



Fischer Panda®

Power wherever you are™



Seafari Quest - Dimensions

QUEST COMPACT

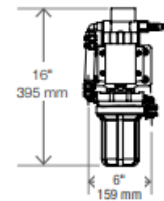
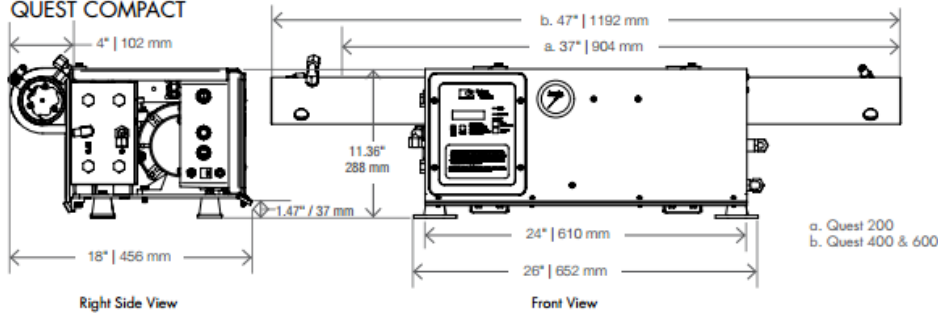

Fresh Water Flush (optional)

QUEST MODULAR

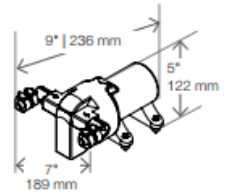
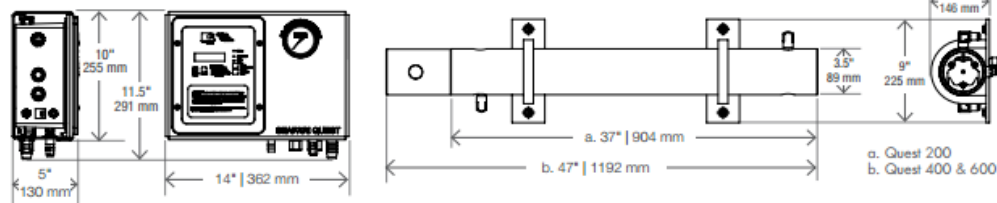

Booster Pump Assembly (optional)

Right Side View

Front View

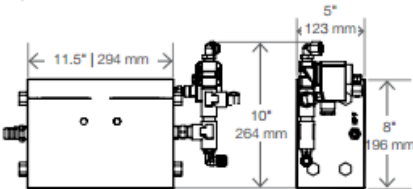

Energy Transfer Device

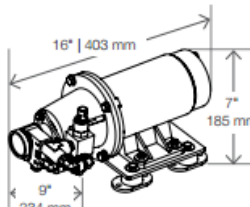

Feed Pump Assembly

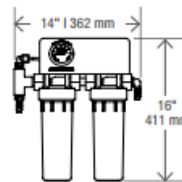

Dual Pre/Post Filter

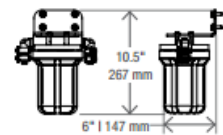

Sea Strainer

