

AC power from shore power
 AC power from AC generator
 AC power from PMG generator over inverter
 AC power from the battery

DC generator to battery
 Charging the battery from shore power

DC power from solar
 DC power from alternator / engine
 DC power / battery for E Mobility

Inputs:
 AC generator input
 Shore power input
 PMG generator input (without inverter)
 Battery 12V / 24V or 48V

Outputs:
 Battery 12V / 24V or 48V
 AC load 1 (consumers, shore power, battery, generator)
 AC load 2 (never over battery - ONLY shore or generator)

ONE FISCHER PANDA

WE ARE HERE FOR YOU

WHEREVER YOU ARE

WHEREVER YOU GO

WHEREVER THE FUTURE
 AWAITS YOU



Fischer Panda GmbH
 Otto-Hahn-Str. 40
 33104 Paderborn
 Germany

Tel. : +49 5254 9202-0
 Email : info@fischerpanda.de
 Web : onefischerpanda.com

PowerMaster

Power Management System

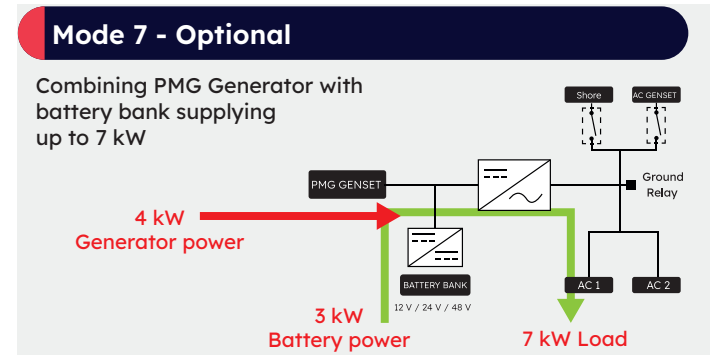
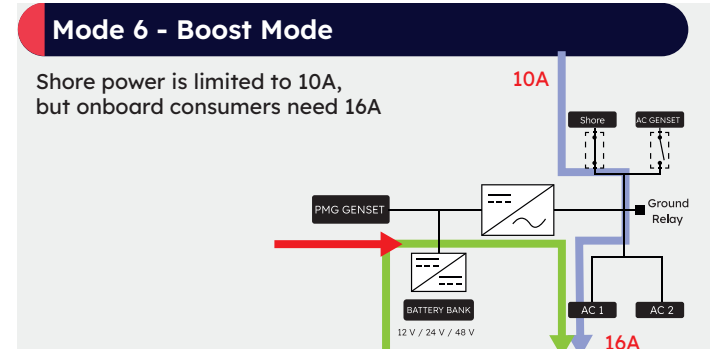
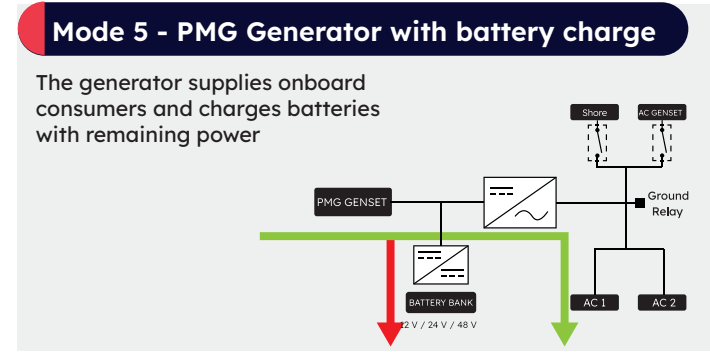
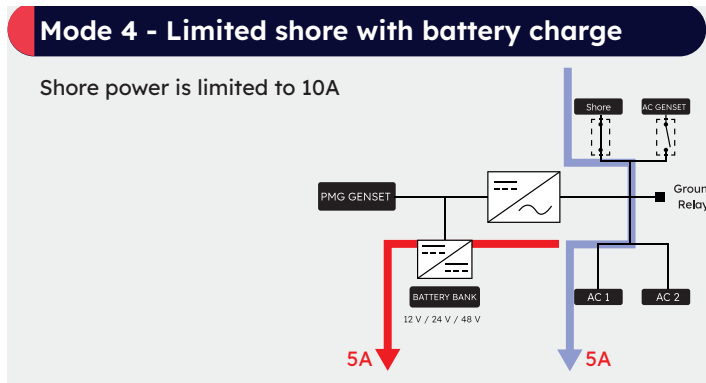
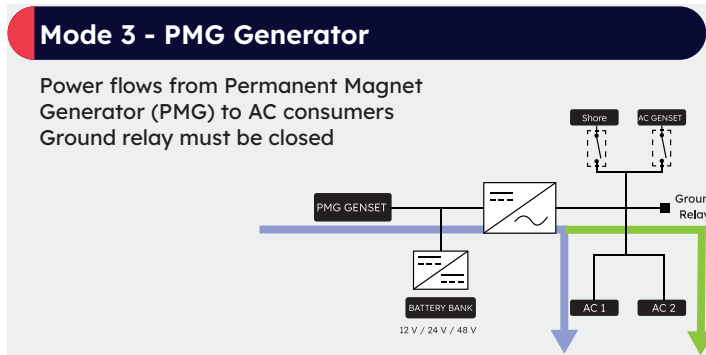
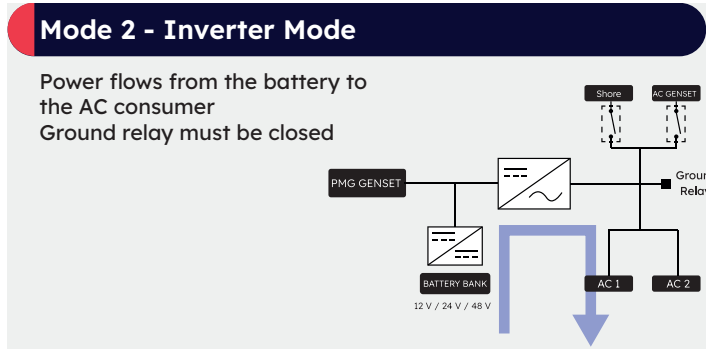
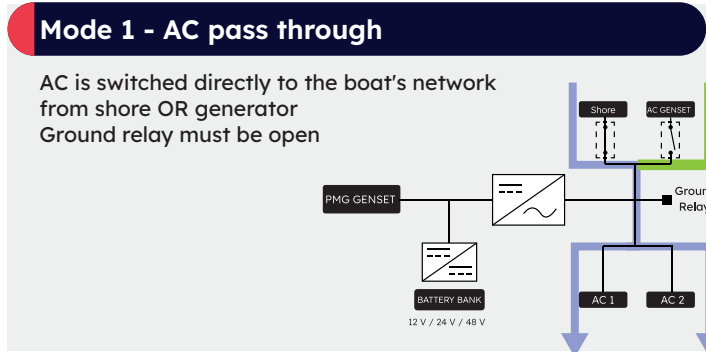
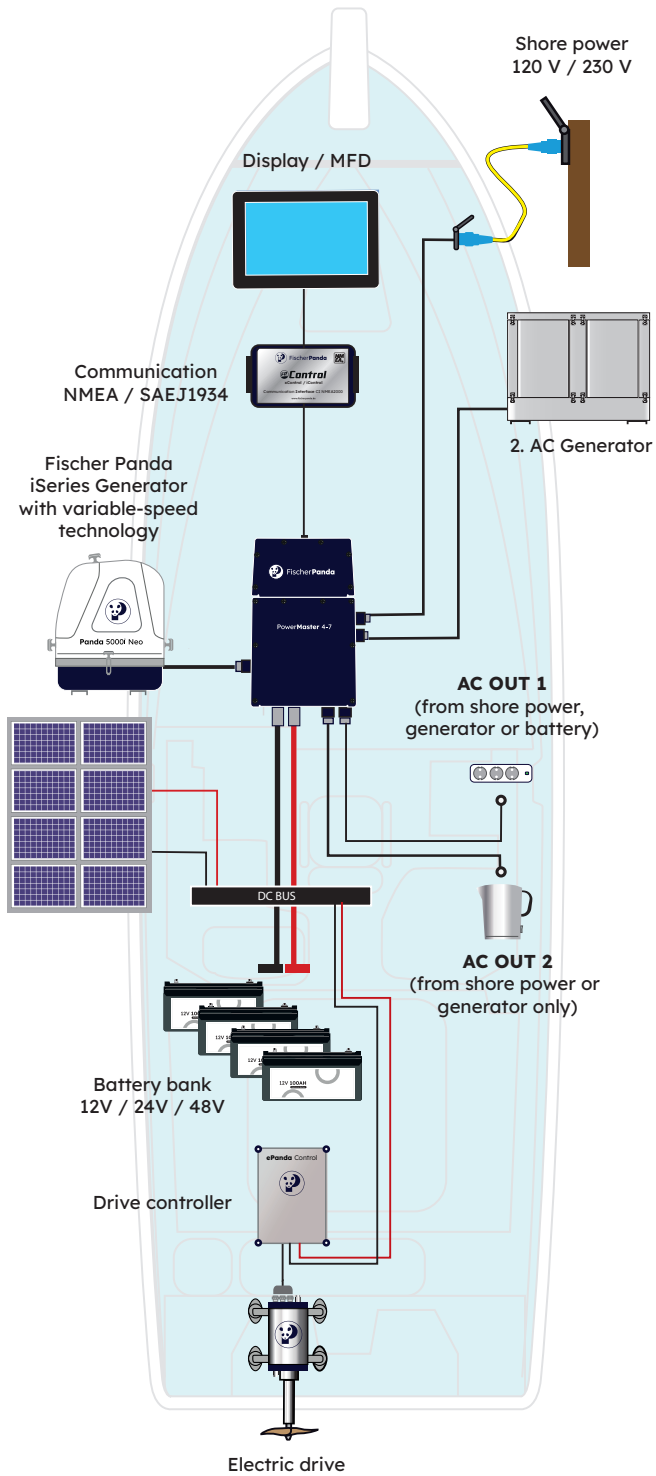

FischerPanda UK | POWER SOLUTIONS

@ Yw6
Fischer Panda UK | Power Solutions
 17 Blackmoor Road, Ebblake Industrial Estate
 BH31 6AX, Verwood
 +44 1202 820 840 | info@fischerpanda.co.uk
 www.fischerpanda.co.uk