



 Evaporatore per montaggio sottotetto, dedicato alla climatizzazione di spazi di media dimensione. Disponibile anche con uscita tubi a destra, con comandi manuali o con centralina elettronica di controllo.

 Evaporateur pour montage sous plafond, conçu pour la climatisation de espaces de moyenne dimension. Disponible aussi avec sortie tuyaux à droite, avec commandes manuelles ou centrale digitale de contrôle.

 Evaporator under-roof mounted, used for conditioning medium sized spaces. Also available with fittings on right side, with manual controls or digital control unit.

 Verdampfer für die Montage unterhalb vom Dach, benutzt für die Klimatisierung von mittelgrösseren Räume. Auch mit Schlauchausgang an der rechten Seite, mit manuelle Bedienungen oder digitales Steuergerät lieferbar.

 Evaporador para montar bajo del techo, usado para el acondicionamiento de espacios medianos. También disponible con recores para ser montado al lado derecho, con controles manuales o con centralita digital de control.

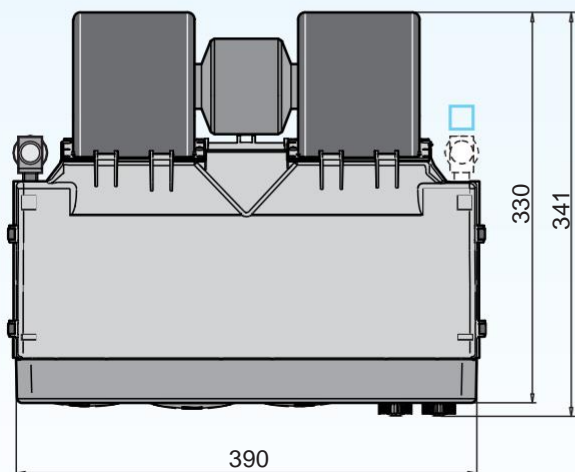
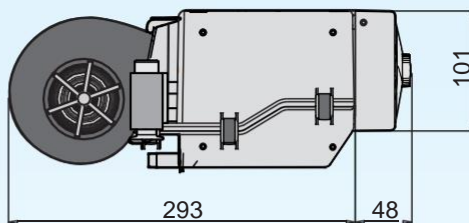
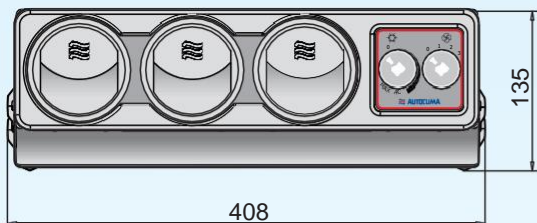

Comandi manuali
Commandes manuelles
Manual controls
Manuelle Bedienungen
Controles manuales



❄️ 12V cod.20201435
24V cod.20201436

❄️ □ 12V cod.20201467
24V cod.20201468

Centralina elettronica
Centrale digitale de control
Digital control unit
Digitales Steuergerät
Centralita digital de control



❄️ 12V cod.20201506
24V cod.20201515

❄️ (E 40) - Solo AC / Only AC / Seulement Climatisation / Nur Klimatisierung / Seulemente AA

□ Uscita tubi DX / RIGHT side fittings / Sortie tuyaux à DROITE / Schlauchausgang an der RECHTEN Seite / Reacores al lado DERECHO

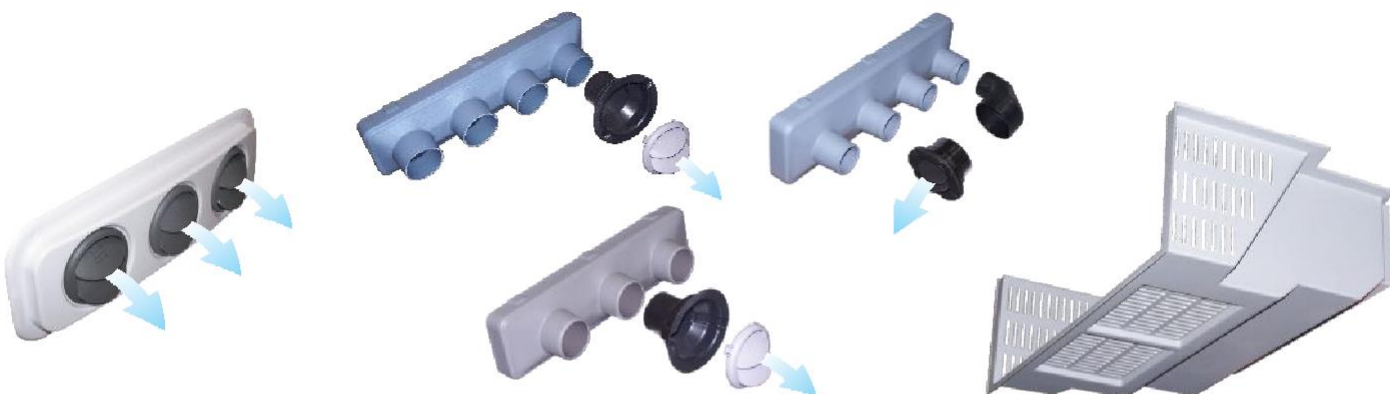

A richiesta sono disponibili accessori per la distribuzione dell'aria ed un kit copertura per il fissaggio sottotetto.
Sur demande sont disponibles accessoires pour la distribution de l'air et une cage pour installation sous toit.
Upon request are available accessories for air distribution and a casing kit for under-roof installation.
Auf Anfrage sind vorhandene Zubehöre für Luftzufuhr und ein Unterdach Verdampferdeckungskit lieferbar.
Sobre consulta están disponibles accesorios por la distribución de l'aire y un kit de cobertura evaporador bajo techo.

E 40

- Potenza frigorifera
- Tensione alimentazione
- Assorbimento elettrico
- Portata aria
- Refrigerante
- Peso

- Puissance frigorifique
- Tension d'alimentation
- Absorption électrique
- Débit air
- Réfrigérant
- Poids

- Cooling capacity
- Working voltage
- Power consumption
- Air flow
- Coolant
- Weight

- Kälteleistung
- Spannung
- Stromverbrauch
- Gebläseleistung
- Kühlmittel
- Gewicht

- Potencia frigorífica
- Tension de alimentacion
- Intensidad absorbida
- Caudal de aire
- Refrigerador
- Peso

4 kW
12Vc.c / 24Vc.c
12A (12V) / 6A (24V)
450 m³/h
R134a
5,5 Kg

La nostra società si riserva il diritto di migliorare e modificare ciascuno dei modelli illustrati, senza alcun preavviso.

Notre Société se réserve le droit d'améliorer et de modifier sans aucun préavis chacun des modèles ci-illustrés.

The company reserves the right to modify any design in the model without prior notice as per our policy of continuous improvement of design, quality and performance.

Unsere Firma behält sich das Recht vor, jeden Modell hier erläutert ohne Vorankündigung zu ändern und verbessern.

La compañía se reserva el derecho a modificar cualquier diseño en los modelos sin previo aviso debido a la política de continua mejora en el diseño, en la calidad y en el rendimiento



Fischer Panda UK

17 Blackmoor Road, Ebblake Estate
Wood, Dorset BH31 6AX
Tel: 01202 820840
Email- info@fischerpanda.co.uk
www.fischerpanda.co.uk