



# Fischer Panda<sup>®</sup>

Power wherever  
you are™

## Fischer Panda 20kW 48V 1200rpm drive

### Technical specifications:

Voltage: 48V  
Input power: 22 kW  
Shaft power: 20 kW  
RPM: 1200  
Nm: 160  
Weight: 58kg

Art-No: 0015608

Our shaft motors are made of heavy duties and have a double-walled aluminum housing which is water-cooled with integrated thrust bearings.

They are without gear, brushless, sensorless and have no oil filling.

This makes our engines: durable, efficient and low maintenance!

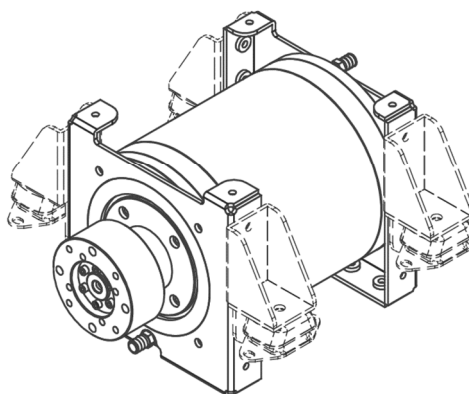
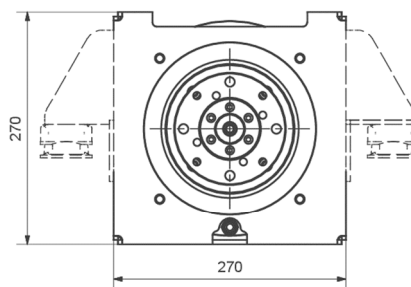
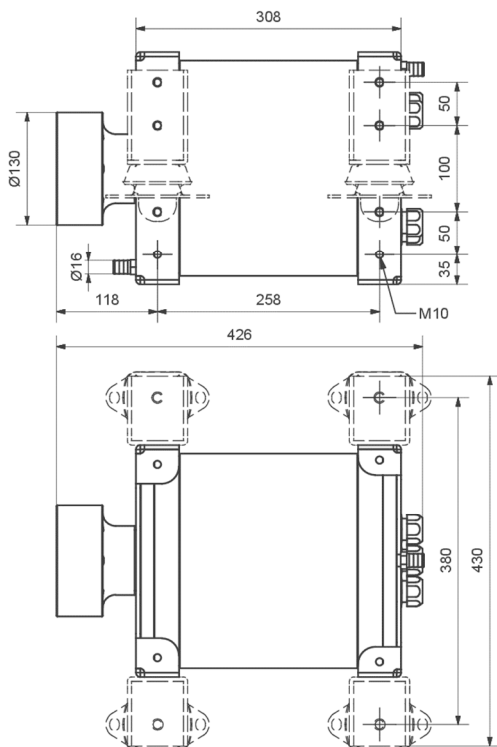
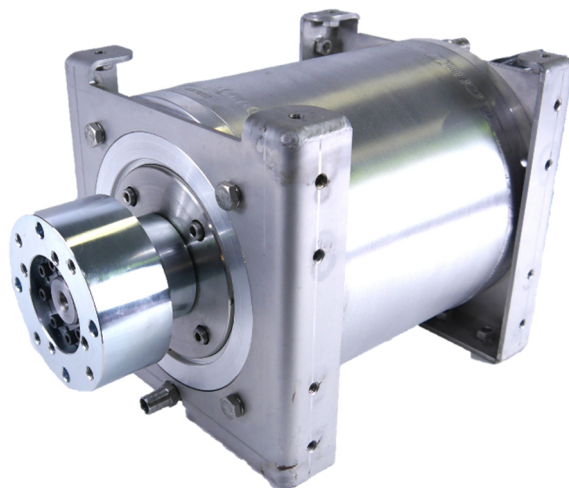

**Fischer Panda UK Limited**  
17 Blackmoor Road,  
Ebble Estate  
Verwood, Dorset  
BH31 6AX



Tel: +44 (0)1202 820840  
Fax: +44 (0)1202 828688



Email: [info@fischerpanda.co.uk](mailto:info@fischerpanda.co.uk)  
Web: [www.fischerpanda.co.uk](http://www.fischerpanda.co.uk)